

Fixing Quantities

Length of Nominal Dome Side (mm)	Number of fixings per side
600, 750	2
900, 1050, 1200	3
1350, 1500, 1650	4
1800, 1950	5
2100, 2250	6
2400	7

(All fixings supplied in packs of 5.)

Installation Instructions

Mardome Contents

i Please unpack and check that all correct parts are included and undamaged.

All **Mardome Reflex**

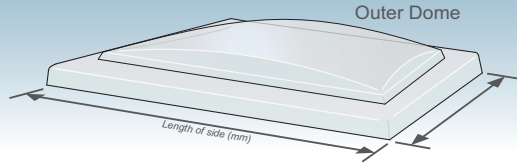

With this assembly, you will receive:
Reflex Dome Fixings and Accessories

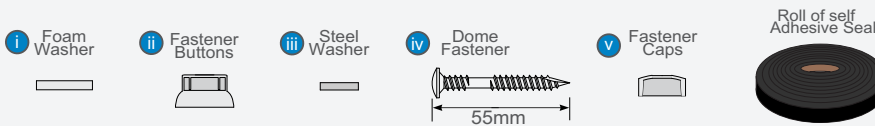

Mardome Installation

⚠ Please note that all *Health and Safety Regulations* must be followed on site throughout the installation process.

c **Reflex Dome Adhesive Seal Application**

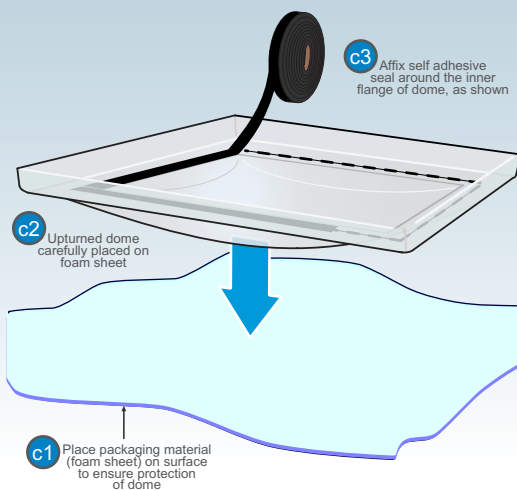

Reflex dome on to existing upstand

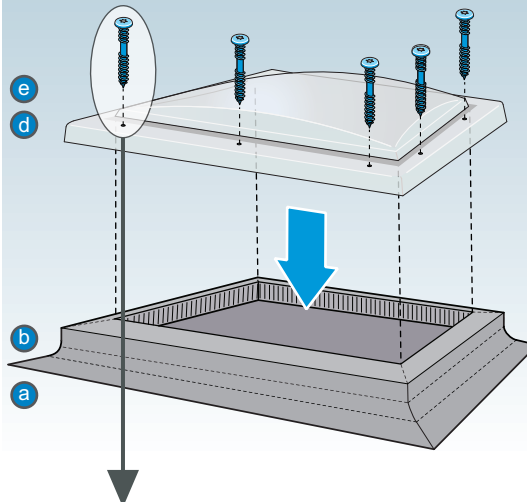

a Install roof covering to cover existing upstand in accordance with manufacturer's installation recommendations.

⚠ N.B. It is important that there should be no excessive build up of layers, the top surface should be level and free from any protrusions or projections which may prevent adequate weather proofing.

b Carefully remove dome from its packaging.

c Affix the supplied self adhesive seal to the underside of the flange on the dome.

⚠ N.B. Protect top of dome using cloth, sheet or foam packaging.

d Pre-drill holes through dome on all sides at 5mm diameter.

See above **Fixing Quantities** table for the correct quantity of holes required for the size of the dome.

⚠ N.B. Length of side refers to the nominal dome size (equivalent to external size of existing upstand.)

e Place dome squarely on top of the completed upstand.

f Fix the dome to the existing upstand. Use 55mm dome fastener with fastener button and both steel and foam washers.

g Fit fastener caps to each button.



Adhesive Seal and Dome Fixing

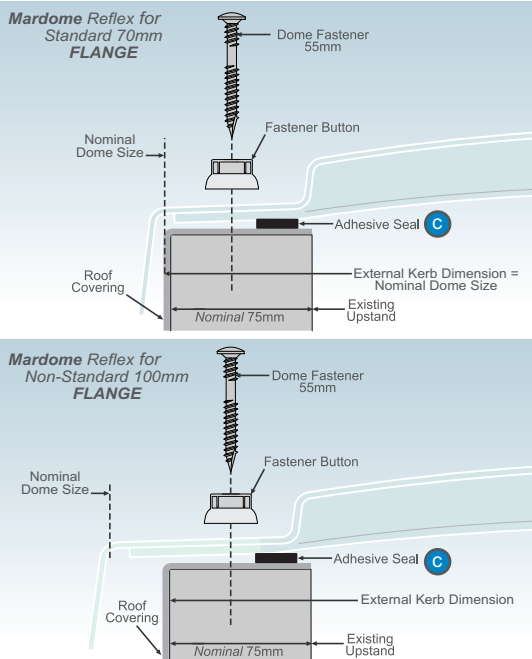

Dome Installation Details

f 9 For All Reflex Domes

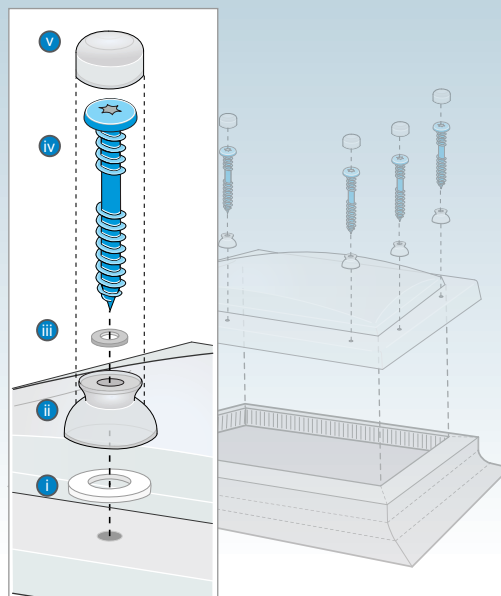

Ⓞ TECHNICAL SUPPORT: For any technical information/queries please contact your supplier.

Mardome Contents

Please unpack and check that all correct parts are included and undamaged.

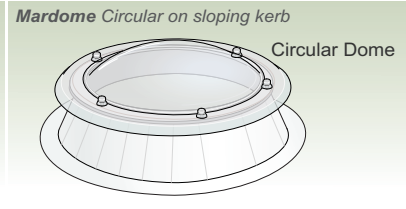
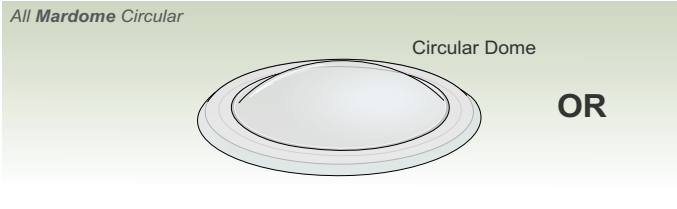

OR

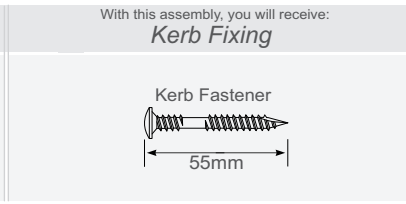
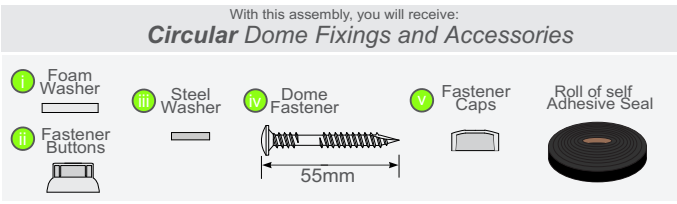

Mardome Installation

Please note that all Health and Safety Regulations must be followed on site throughout the installation process.

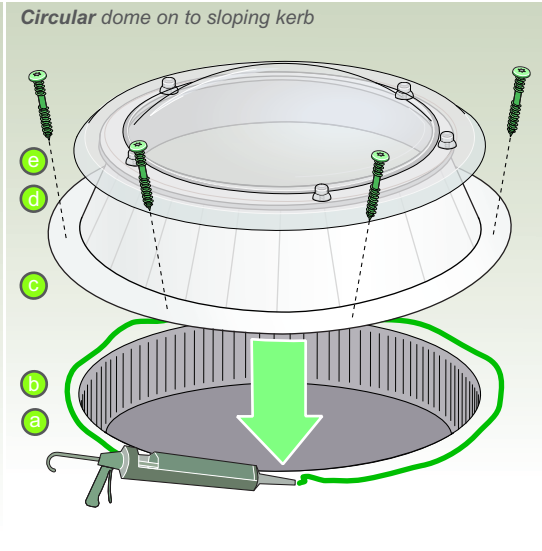
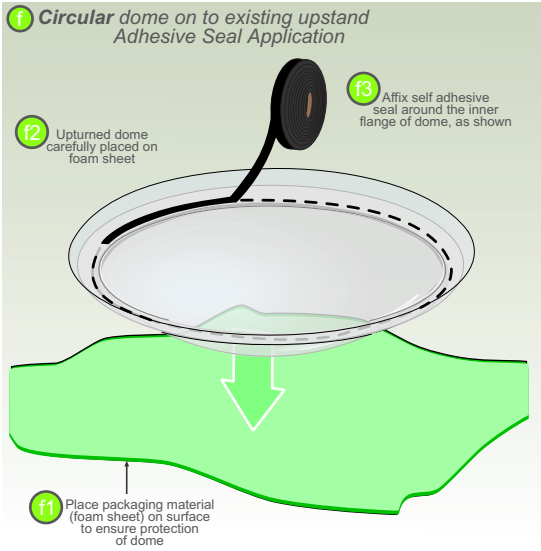

Mardome Installation Continued

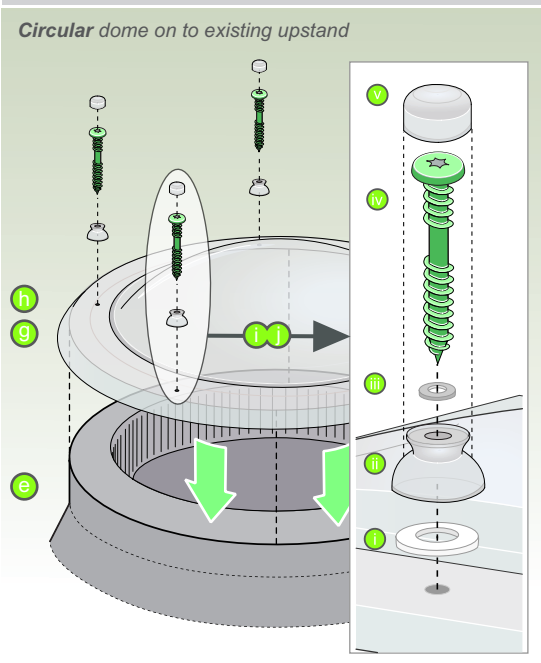

Dome Fixing and Kerb Fixing

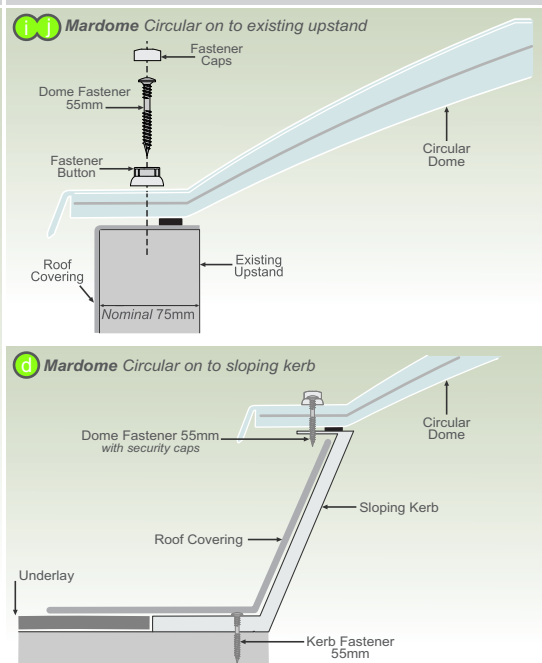

Fixing Quantities

Nominal Diameter of Dome (mm)	Number of fixings (minimum)
600	6
750	8
900	9
1050	10
1200	12
1350	14
1500	15
1800	20

(All fixings supplied in packs of 5.)

i Equal spacing between fixings approximately 300mm

Installation Instructions

ONLY use the fixings supplied!

- a** For circular dome on to existing upstand, go to e.
 - b** Carefully remove dome from its packaging.
 - c** Correctly align sloping kerb assembly with internal roof aperture.
 - d** Fix kerb to the roof using the 55mm kerb fastener.
- See above **Fixing Quantities** table for the correct quantity of holes required for the size of the dome.

e Install roof covering to cover existing upstand or sloping kerb in accordance with manufacturer's installation recommendations.

N.B. It is important that there should be no excessive build up of layers, the top surface should be level and free from any protrusions or projections which may prevent adequate weather proofing.

For circular dome on to sloping kerb, installation is now complete.

f Carefully remove dome from its packaging and affix the supplied self adhesive seal to the underside of the flange on the dome.

g Pre-drill holes through dome at 5mm diameter.

See above **Fixing Quantities** table for the correct quantity of holes required for the size of the dome.

h Correctly align dome and place on top of the completed upstand.

i Fix the dome to the existing upstand using 55mm dome fastener with button and both steel and foam washers.

j Fit fastener caps to each fastener button.

TECHNICAL SUPPORT: For any technical information/queries please contact your supplier.